

# Inscribed Angles

State if each angle is an inscribed angle. If it is, name the angle and the intercepted arc.

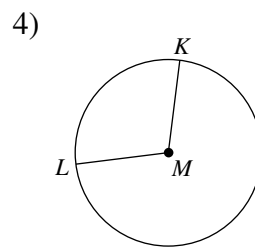

Find the measure of the arc or angle indicated.

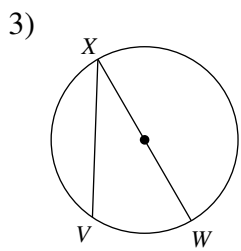
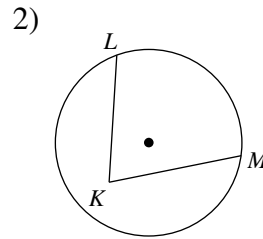
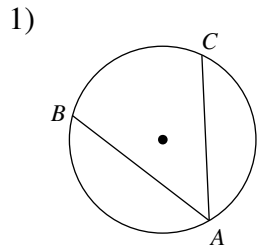
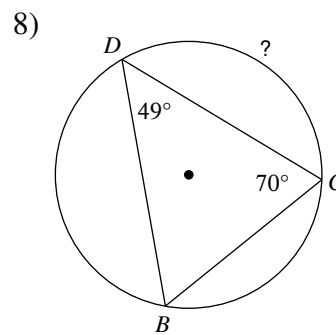
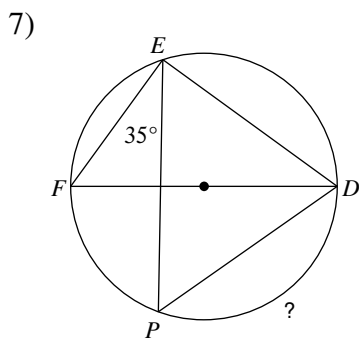
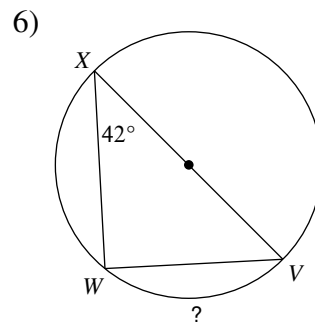
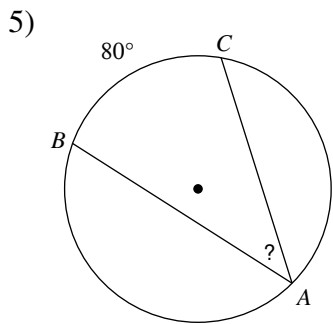

9)

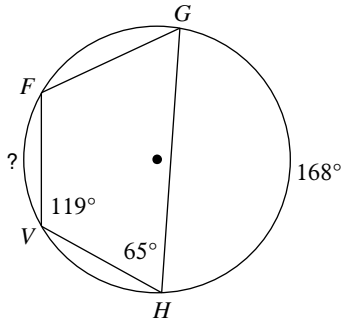

10)

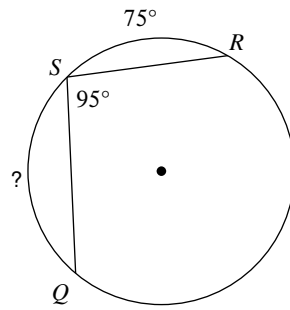

**Solve for  $x$ .**

11)

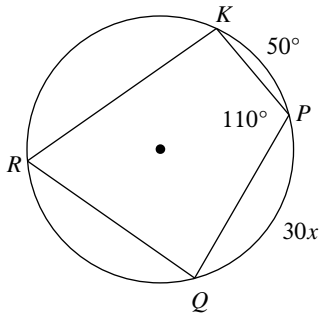

12)

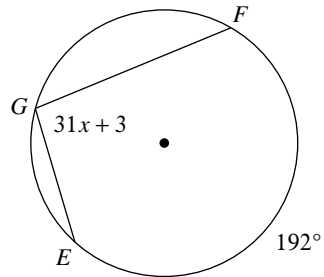

**Find the measure of the arc or angle indicated.**

13) Find  $m\angle NLM$

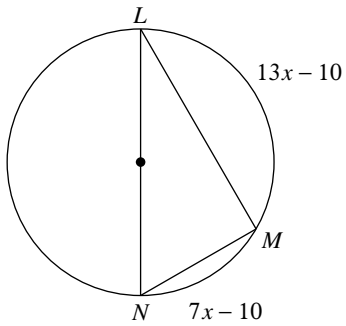

14) Find  $m\widehat{FGH}$

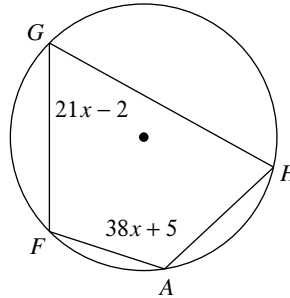

**Solve for  $x$  and  $y$ .**

15)

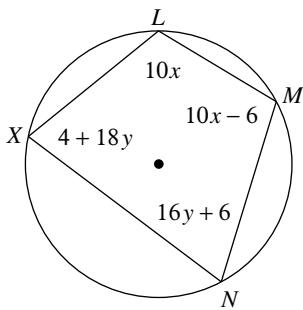

16)

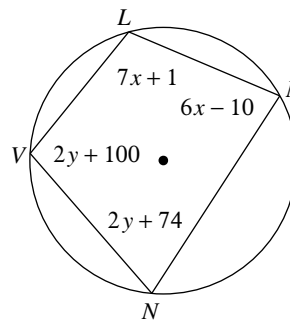

# Inscribed Angles

State if each angle is an inscribed angle. If it is, name the angle and the intercepted arc.

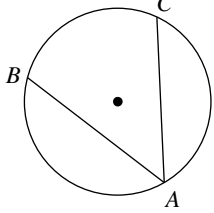
1)   
 Yes;  $m\angle BAC$ ,  $\widehat{BC}$

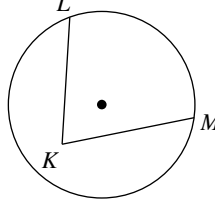
2)   
 No

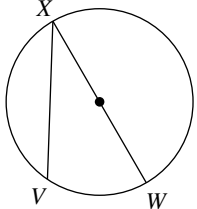
3)   
 Yes;  $m\angle WXV$ ,  $\widehat{VW}$

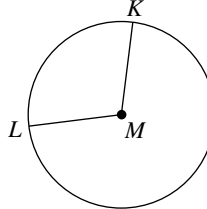
4)   
 No

Find the measure of the arc or angle indicated.

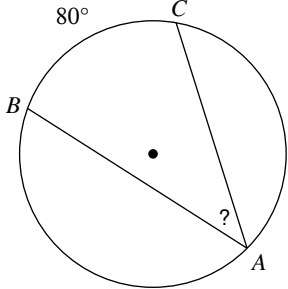
5)   
 $40^\circ$

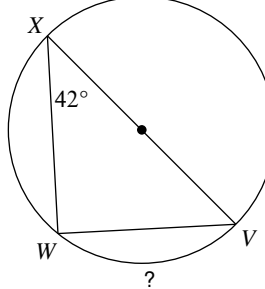
6)   
 $84^\circ$

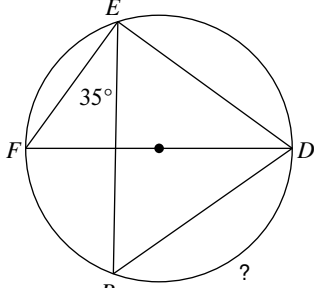
7)   
 $110^\circ$

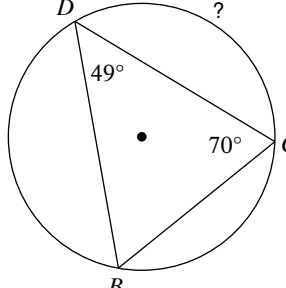
8)   
 $122^\circ$

9)

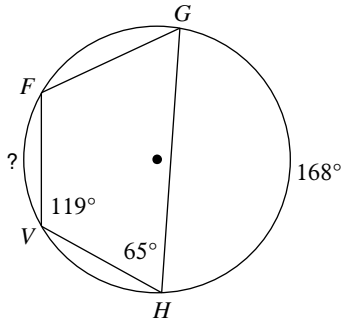

60°

10)

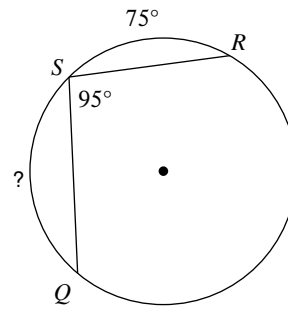

95°

**Solve for  $x$ .**

11)

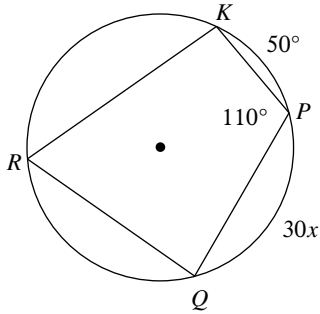

3

12)

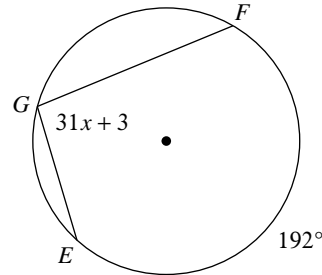

3

**Find the measure of the arc or angle indicated.**

13) Find  $m\angle NLM$

30°

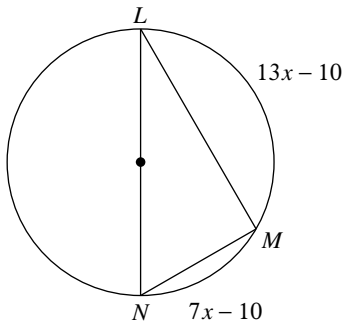

14) Find  $m\widehat{FGH}$

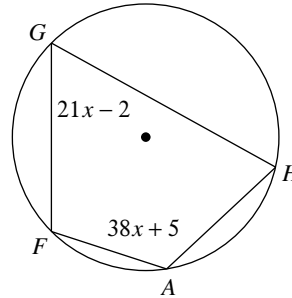

238°

**Solve for  $x$  and  $y$ .**

15)

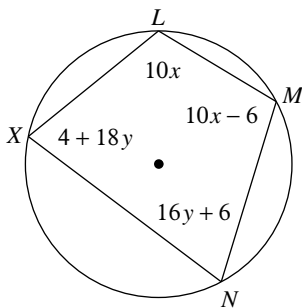

$x = 11, y = 4$

16)

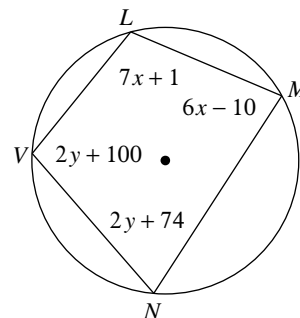

$x = 15, y = 0$